

DELUGE VALVE

MODEL-H2 (CAST STEEL)



TECHNICAL DATA

MODEL	H2 - Cast Steel ASTM A 216 WCB	
NOMINAL SIZE	200, 150, 100, 80 & 50NB	
SERVICE PRESSURE	1.4 to 17.5 kg/sq.cm (20 to 250 psi)	
END CONNECTION	Flange X Flange Groove X Groove	
THREADED OPENING	BSPT	
MOUNTING	Vertical or Horizontal	
FACTORY HYDROSTATIC TEST PRESSURE	35 kg/sq.cm (500 psi)	
FLANGE CONNECTION	ANSI B 16.5 #150 RF, SR is Standard Supply (Contact HD Sales for other options)	
WET PILOT SPRINKLER HEIGHT LIMITATION	As per graph in the catalogue	
NET WEIGHT WITHOUT TRIM	FXE	GXG
	200 NB - 163 kg	146 kg
	150 NB - 86 kg	75 kg
	100 NB - 56 kg	45 kg
	80 NB - 38 kg	32 kg
	50 NB - 33 kg	30 kg
FINISH	Red to RAL 3001	
APPROVAL	UL Listed	
ORDERING INFORMATION	<ol style="list-style-type: none"> 1. Size of valve 2. Flange specification or for Grooved end specify pipe outside diameter 3. Valve mounting- Horizontal or Vertical 4. Trim type 	

GROOVE PIPE SIZE:

NOMINAL SIZE	Pipe OD in mm
2" (50 NB)	60.3
3" (80 NB)	89.0
4" (100 NB)	114.3
6" (150 NB)	165.1
6" (150 NB)	168.3
8" (200 NB)	219.1

NOTE: FOR 6"(150 NB) STANDARD SUPPLY IS 168.3 mm OD GROOVE PIPE.
FOR 165.1mm REQUIREMENT, SPECIFY IN ORDER



DESCRIPTION

Deluge Valve is known as a system control valve in a deluge system, used for fast application of water in a spray system. Deluge valve protects areas such as power transformer installation, storage tank, conveyor protection and other industrial application etc. With the addition of foaming agent, deluge valve can be used to protect aircraft hanger and inflammable liquid fire.

VALVE OPERATION

HD Deluge Valve is a quick release, hydraulically operated diaphragm valve. It has three chambers, isolated from each other by the diaphragm operated clapper and seat seal. While in SET position, water pressure is transmitted through an external bypass check valve and restriction orifice from the system supply side to the top chamber, so that supply pressure in the top chamber act across the diaphragm operated clapper which holds the seat against the inlet supply pressure, because of the differential pressure design. On detection of fire, the top chamber is vented to atmosphere through the outlet port via opened actuation devices. The top chamber pressure cannot be replenished through the restricted inlet port, and the upward force of the supply pressure lifts the clapper allowing the water flow to the system piping network and alarm devices.

TRIM DESCRIPTION

The trims are functionally termed as Dry Pilot Trim, Wet Pilot Trim, Electric Trim and Test & Alarm Trim as per the method of actuation of the deluge valve.

The functionality of these trims are described below:

a) DRY PILOT TRIM (PNEUMATIC RELEASE)

Dry pilot operation uses a pilot line of closed Sprinkles/QB Detectors containing air under pressure, located in the area to be protected. It requires regulated dry air supply with main supply point, through restricted orifice. The air pressure to be maintained as specified in the catalogue of Dry Pilot Actuator (HD 252). The pilot line is connected to air inlet side of actuator. The top chamber of the deluge valve is connected to water inlet side of actuator.

When there is an air pressure drop, or due to release of any of the releasing device on detection of fire, the diaphragm of actuator is lifted and allows the water to drain. This releases the water pressure in the top chamber of the deluge valve, allowing the deluge valve to open and water to flow into the system piping & alarm devices. Recommended air supply pressure for dry pilot trim system is 3.5 kg/sq.cm.

User must install non return valve at air supply connection to deluge valve trim.

In dry pilot trim, an actuator (DPA) is provided. An optional Pneumatic Reset Device (PRD) can be provided, which acts as a manual reset device in the dry pilot line.

b) WET PILOT TRIM (HYDRAULIC RELEASE)

Wet pilot operation uses a pilot line of closed Sprinklers/QB Detectors containing pressurized water, supplied through the upstream side of the Deluge valve, through a restricted orifice. Due to release of any one of the releasing device, the water pressure in the top chamber of the Deluge valve drops and the Deluge valve opens.

c) ELECTRIC RELEASE TRIM

To actuate a Deluge valve electrically, a solenoid valve is provided to drain the water from the top chamber of the Deluge valve. A pressure switch is provided to activate an electric alarm, to shut down the desired equipment or to give "Tripped" indication of the Deluge valve. In addition to this a pressure switch can also monitor "Low air pressure" and "Fire condition" when used in dry pilot air line.

d) TEST AND ALARM TRIM

This trim is supplied with a test valve provided to test the normal operation of the sprinkler alarm bell. The sprinkler alarm can be supplied additionally, which bells on actuation of the Deluge valve.

e) DRAIN AND DRIP TRIM

This consists of main and system drain valve in addition with drip valve.

TRIM MODEL NO.	TRIM DESCRIPTION	MOUNTING	SCHEMATIC NO.
ET-W	Basic Wet Pilot Trim	Vertical	Schematic 1
ET-D	Basic Dry Pilot Trim	Vertical	Schematic 2
ETW-T	Basic Wet Pilot Trim with Test & Alarm Trim	Vertical	Schematic 3
ETD-T	Basic Dry Pilot Trim with Test & Alarm Trim	Vertical	Schematic 4
ETW-D	Basic Wet Pilot Trim with Drip & Drain Trim	Vertical	Schematic 5
ETD-D	Basic Dry Pilot Trim with Drip & Drain Trim	Vertical	Schematic 6
NT-W	Basic Wet Pilot Trim with Test & Alarm Trim and Drip & Drain Trim	Vertical	Schematic 7
NT-D	Basic Dry Pilot Trim with Test & Alarm Trim and Drip & Drain Trim	Vertical	Schematic 8
ET-W	Basic Wet Pilot Trim	Horizontal	Schematic 9
ET-D	Basic Dry Pilot Trim	Horizontal	Schematic 10
ETW-T	Basic Wet Pilot Trim with Test & Alarm Trim	Horizontal	Schematic 11
ETD-T	Basic Dry Pilot Trim with Test & Alarm Trim	Horizontal	Schematic 12
ETW-D	Basic Wet Pilot Trim with Drip & Drain Trim	Horizontal	Schematic 13
ETD-D	Basic Dry Pilot Trim with Drip & Drain Trim	Horizontal	Schematic 14
NT-W	Basic Wet Pilot Trim with Test & Alarm Trim and Drip & Drain Trim	Horizontal	Schematic 15
NT-D	Basic Dry Pilot Trim with Test & Alarm Trim and Drip & Drain Trim	Horizontal	Schematic 16

TRIM TYPES

The trims are designated as following:

W=Wet Pilot trim D=Dry Pilot Trim

a) Type ET-W and ET-D

This type of trim is basic trim required to operate the deluge valve. A solenoid valve for electric remote actuation and pressure switch for sensing & annunciation are optional.

b) Type ETW-D and ETD-D

This trim type is a combination of components of the ET trim along with the drip and drain trim. A solenoid valve for electric remote actuation and pressure switch for sensing & annunciation are optional.

c) Type ETW-T and ETD-T

This trim type is a combination of components of the ET trims along with the test and alarm trim. A solenoid valve for electric remote actuation and pressure switch for sensing & annunciation are optional.

d) Type NT-W and NT-D

This trim type is a combination of components of the ET trim along with the test and alarm trim as well as the drip and drain trim. A solenoid valve for electric remote actuation and pressure switch for sensing & annunciation are optional.

RESETTING PROCEDURE

A. When priming connection is below the upstream valve (Stop Valve)

- (i) Close the upstream side stop valve provided below the deluge valve to cease the flow of water.
- (ii) Open both the drain valves/ drain plugs and close when the flow of water has ceased.
- (iii) Close the release device/replace the Sprinkler if release was through Sprinkler/ QB Detector.
- (iv) Inspect and restore/ replace/ repair if required, the section of the detection system subjected to "Fire condition".
- (v) In case of dry pilot detection system, open the air supply valve to build-up air pressure. Open the priming valve fully. When top chamber pressure is more than 50% of the inlet pressure, open the upstream side of the stop valve provided below the Deluge valve. No water should flow into the system.
- (vi) When priming shut off valve (optional) is provided for resetting, then the water need to be drained from upstream side of valve.

B. When priming connection is from the inlet of Deluge Valve (Auto resetting)

- (i) The deluge valve will reset automatically when releasing devices which were responsible for deluge valve opening are closed or restored back to their original status (i.e closing of ERS or replacing the damaged Sprinkler if release was through Sprinkler/ QB Detector, or closing of Solenoid valve). The reset time may be long or cause vibration while closing, depending upon the system back pressure at the outlet of the valve.

CAUTION

- (a) Do not close the priming valve, downstream and upstream stop valves, while system is in service
- (b) The releasing device must be maintained in the open position, when actuated, to prevent the deluge valve from closure if anti shut off valve is not provided
- (c) While using a deluge valve in the wet pilot system the height and the length of the wet pilot detection line is to be limited as shown in the wet pilot sprinkler height limitation graph
- (d) Do not connect the Sprinkler Alarm outlet drain line to close a common drain as it may create back pressure & Sprinkler Alarm may not function
- (e) Deluge valve must have support to absorb sudden opening or closing vibration shock to the piping
- (f) To avoid water damage, take precautions when opening the water supply main control valve, since water will flow from all open system valves
- (g) The responsibility of maintenance of the protection system and devices in proper operating condition lies with the owner of the system.
- (h) Deluge Valve & its trim shall be maintained at a minimum temperature of 4°C. Heat tracing is not permitted.
- (i) Deluge Valve must be used in pressurised system.

SYSTEM TESTING PROCEDURE

- (i) Keep the upstream side of the stop valve partially open. To avoid water flow to system side, close the system side stop valve. This valve is to be kept in open position after the testing is completed.
- (ii) Let any of the release devices to trip. This will result in a sudden drop of water pressure in the deluge valve top chamber which in turn will open the deluge valve. Close the upstream side stop valve immediately.
- (iii) Reset the valve as per the procedure given under heading "RESETTING PROCEDURE FOR THE DELUGE VALVE"

INSPECTION AND MAINTENANCE

Installed system piping network must be flushed properly before placing the Deluge valve in service.

A qualified and trained person must commission the system. After few initial successful tests, an authorized person must be trained to perform inspection and testing of the system. It is recommended to have regular inspection and test run of the system as per NFPA guidelines or in accordance to the organisation having local jurisdiction.

(i) **WARNING**

Inspection and testing is to be carried out only by authorised and trained personnel. **DO NOT TURN OFF** the water supply or close any valve to make repair(s), or test the valve without placing a roving fire patrol in the area covered by the system. Also inform the local security personnel and central alarm station, so that there is no false alarm signal.

It is recommended to carry out physical inspection of the system at least twice in a week. The inspection should verify that all the control valves are in proper position as per the system requirement and that there are no damages to any component.

The frequency of inspections must be increased in the presence of contaminated water supplies, corrosive/scaling water supplies, and corrosive atmospheres.

(ii) **NORMAL CONDITION**

- (a) All main valves are open and are sealed with tamper proof seal
- (b) Drain valves must be kept closed
- (c) No leak or drip is detected from the drip valve
- (d) All the gauges except the system side water pressure gauge, should show the required pressure
- (e) There should be no leakage in the system

(iii) **NORMAL CONDITION TEST**

- (a) The system should be checked for normal condition at least once in a week
- (b) Test the sprinkler alarm bell or electric alarm by turning the alarm test valve to the test position. The alarm should sound. This test should be carried out at least once in a week
- (c) Depress the drip valve knob. Significant accumulation indicates a possible seat leakage
- (d) Conduct the water flow test as per the procedure of system testing at least once a month

(iv) **PERIODIC CHECK**

Conduct the water flow test by actuating few of the release devices provided in the system. Clean all strainer(s) and line restriction nipple. This test is to be carried out at least once in three months.

ABNORMAL CONDITION

(i) **ALARM FAILS TO SOUND**

- (a) Check for any obstruction in the alarm test line, make certain that the sprinkler alarm is free to operate
- (b) If an electric alarm is provided, check the electrical circuitry to the alarm

(ii) **FALSE TRIPS**

- (a) Check for clogging in priming line, restriction orifice check valve, priming valve & strainer
- (b) Leakage in the release system
- (c) The deluge air line restriction orifice clogged or low supply pressure

(iii) **LEAKAGE THROUGH THE DELUGE VALVE**

- (a) Damaged deluge valve seat or obstruction on the seat face by foreign object
- (b) Leakage in release system
- (c) Partly clogged priming line restriction orifice check valve
- (d) Low air pressure on release system line or leakage in release system

NOTE:

- (1) UL Listing is valid only when Deluge Valve is installed with trim set as per trim drawing.
- (2) The trip time of deluge valve on-off device through detection network, will depend on volume of detection network. If the trip time of deluge valve is more, then it can be substantially reduced by installing check valve in branch of release line in the detection network. The check valve flow shall be towards releasing device.
- (3) The pneumatic system must have restricted orifice at air or gas supply point. The restriction nozzle are supplied with HD dry pilot actuation trim.
- (4) UL Listing is valid only when Listed Solenoid Valve provided for electric operation of the deluge valve is retained in the trim. If any other solenoid valve is used, the deluge valve trip time may be quite high or deluge valve may not trip.
- (5) The Pressure Gauges standard supply is 300 psi for water gauge for system pressure upto 175 psi. If system pressure is more than 175 psi, then order for 600 psi water pressure gauges.

DELUGE VALVE MODEL - H2 SIZE 200 / 150 / 100 / 80/ 50 NB

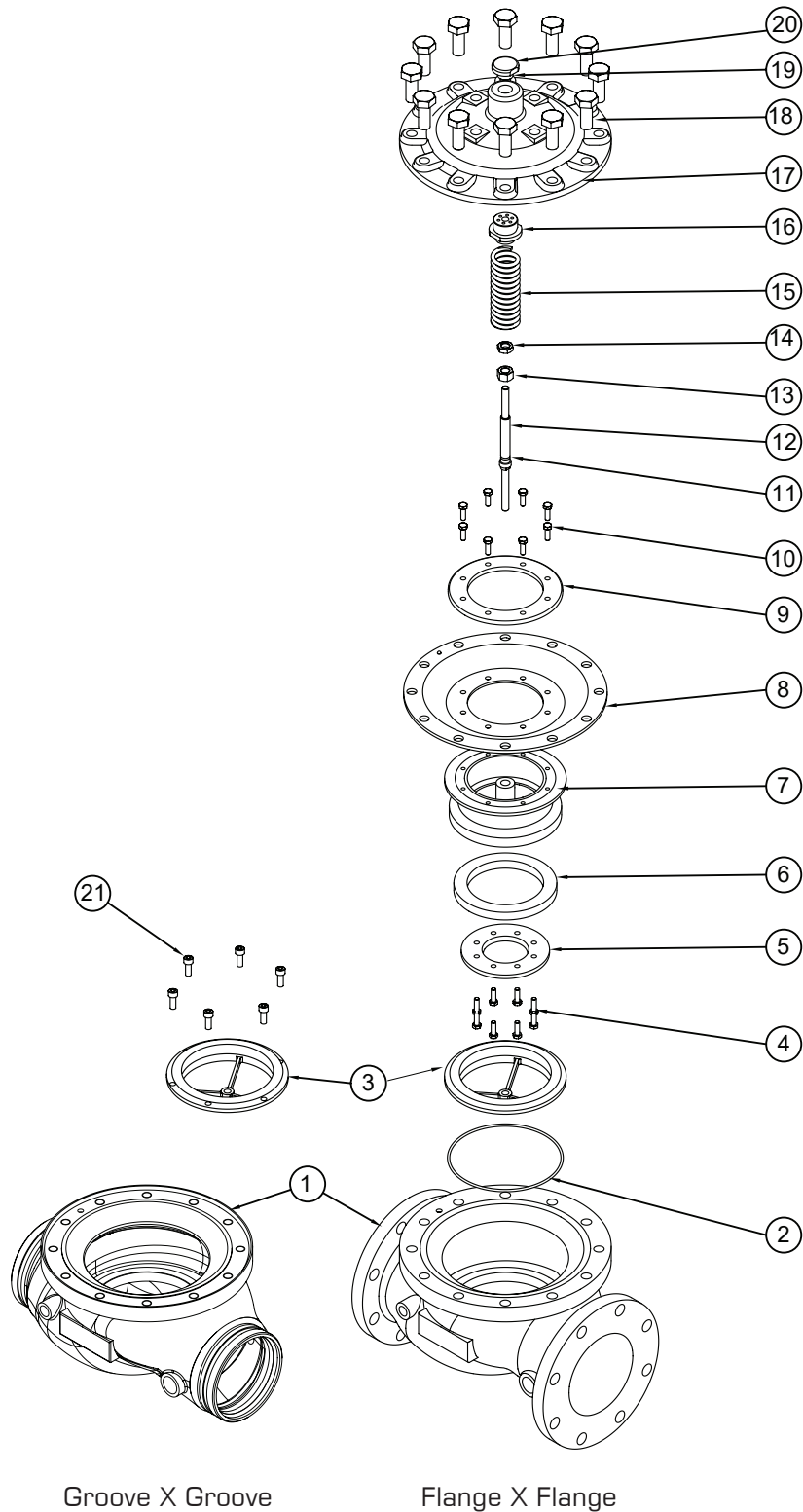

DELUGE VALVE MODEL - H2 SIZE 200 / 150 / 100 / 80 / 50 NB

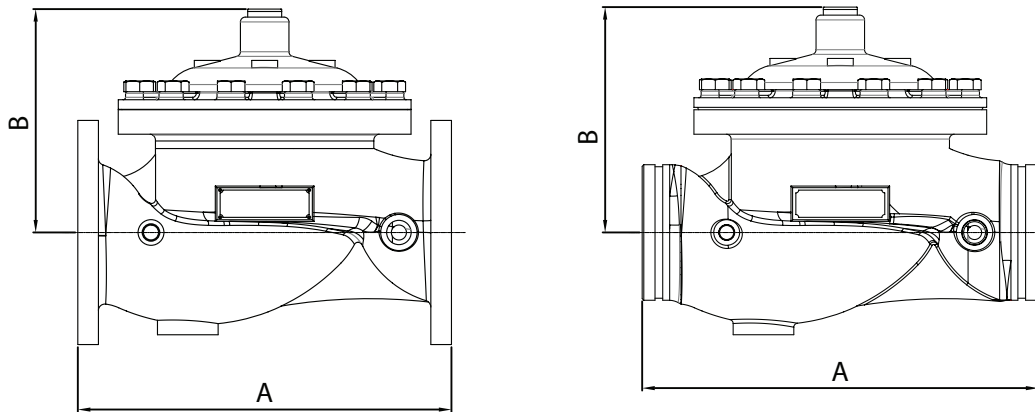

DIMENSION in millimeter (Approximate)

VALVE NOMINAL SIZE	A		B
	F x F	G x G	
200 NB	552	580	332
150 NB	462	490	282
100 NB	412	440	245
80 NB	372	400	232
50 NB	320	350	232

ITEM NO.	PART NO.					DESCRIPTION	QTY				MATERIAL SPECIFICATION
	200 NB	150 NB	100 NB	80 NB	50 NB		200 NB	150 NB	100 NB	80/50 NB	
1	NA	NA	NA	NA	NA	HOUSING	1	1	1	1	CAST STEEL
2	8561	9783	9784	9791	9791	"O" RING	1	1	1	1	NEOPRENE RUBBER
3	3937	3936	3935	3934	3934	SEAT	1	1	1	1	STAINLESS STEEL *
4	9151	9112	9112	-	-	BOLT	8	4	4	-	STAINLESS STEEL
5	3546	3545	3544	3543	3543	RUBBER CLAMP	1	1	1	1	DUCTILE IRON **
6	117466	117465	117464	117463	117463	RUBBER SEAT	1	1	1	1	EPDM ***
7	4034	3990	4011	4041	4041	CLAPPER	1	1	1	1	DUCTILE IRON **
8	117462	117461	117460	117459	117459	DIAPHRAGM	1	1	1	1	EPDM ***
9	3542	3541	3540	3539	3539	CLAMP RING	1	1	1	1	DUCTILE IRON **
10	8806	9151	9151	9151	9151	BOLT	12	8	8	8	STAINLESS STEEL
11	114221	114221	114221	114221	114221	"O" RING	1	1	1	1	NEOPRENE RUBBER
12	4029	3996	4007	4020	4020	SPINDLE	1	1	1	1	STAINLESS STEEL
13	8838	8838	8838	8838	8838	NUT	1	1	1	1	STAINLESS STEEL
14	9184	9184	9184	9184	9184	LOCK NUT	1	1	1	1	STAINLESS STEEL
15	2980	2979	2978	2977	2977	SPRING	1	1	1	1	STAINLESS STEEL
16	4033	3998	4010	3983	3983	ADAPTOR	1	1	1	1	BRASS
17	NA	NA	NA	NA	NA	COVER	1	1	1	1	CAST STEEL
18	9008	9049	9051	9027	9027	BOLT	16	12	12	12	CARBON STEEL
19	9982	9982	9982	9982	9982	"O" RING	1	1	1	1	NEOPRENE RUBBER
20	2514	2514	2514	2514	2514	PLUG	1	1	1	1	STEEL PLATED
21	8843	-	-	-	-	ALLEN BOLT	6	-	-	-	STAINLESS STEEL

* Stainless Steel is standard supply, Bronze is an optional supply.

** Ductile Iron is standard supply, Bronze/Stainless Steel is an optional supply.

*** EPDM is standard supply with Stainless Steel Seat, Neoprene is an optional supply with Stainless Steel & Bronze Seat.

NA - PART REPLACEMENT NOT AVAILABLE

SCHEMATIC FOR BASIC WET PILOT TRIM FOR DELUGE VALVE MODEL - H2 FOR VERTICAL MOUNTING

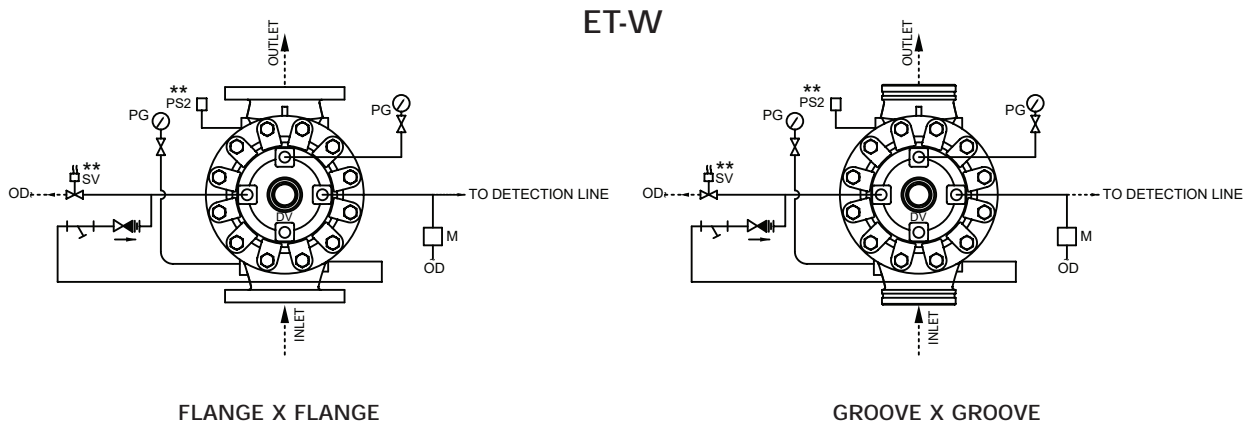

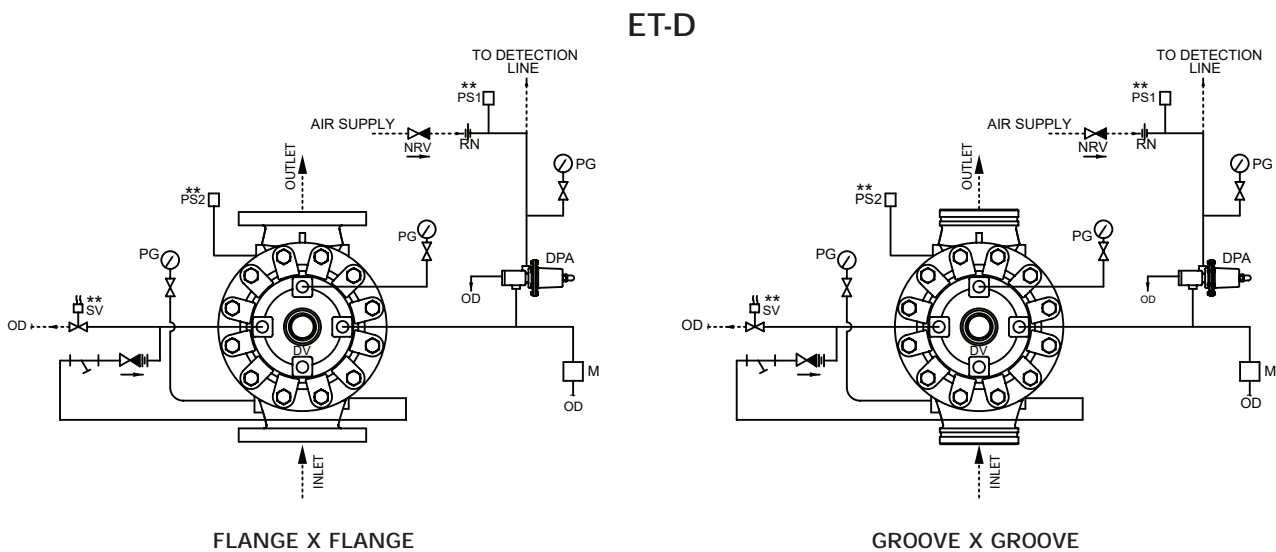

SCHEMATIC 1

SCHEMATIC FOR BASIC DRY PILOT TRIM FOR DELUGE VALVE MODEL - H2 FOR VERTICAL MOUNTING



SCHEMATIC 2

ABBREVIATION & SYMBOLS

DV DELUGE VALVE	G SPRINKLER ALARM (WMG)	 NRV WITH RESTRICTION HEX NIPPLE
M EMERGENCY RELEASE STATION	PG PRESSURE GAUGE	 VALVE
RN RESTRICTION NOZZLE (AIR LINE)	OD OPEN DRAIN	 STRAINER
SV SOLENOID VALVE	DPA DRY PILOT ACTUATOR	--- BY USER
PS1 LOW AIR ALARM PRESSURE SWITCH	NRV NON RETURN VALVE	
PS2 WATER FLOW PRESSURE ALARM SWITCH	** OPTIONAL	

**SCHEMATIC FOR BASIC WET PILOT TRIM FOR DELUGE VALVE
MODEL - H2 FOR VERTICAL MOUNTING**

ETW-T

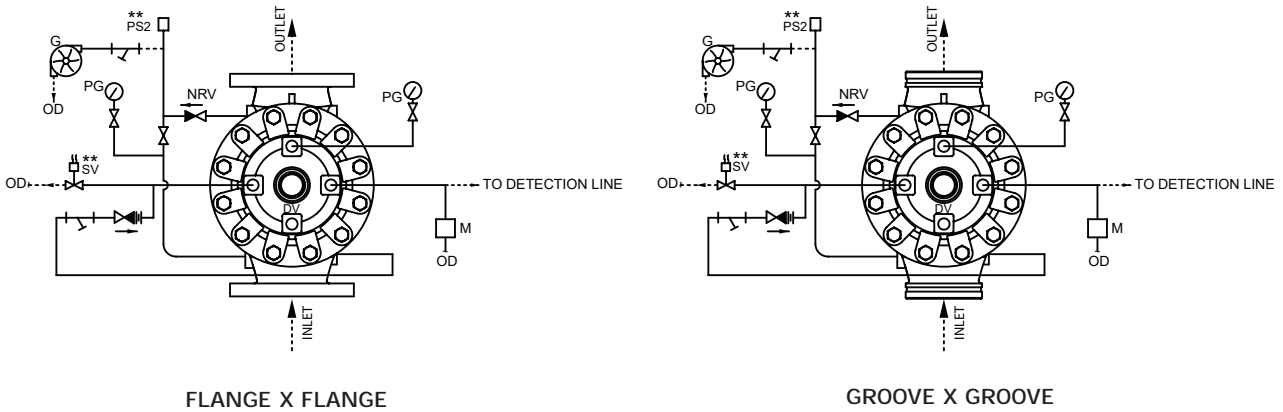

SCHEMATIC 3

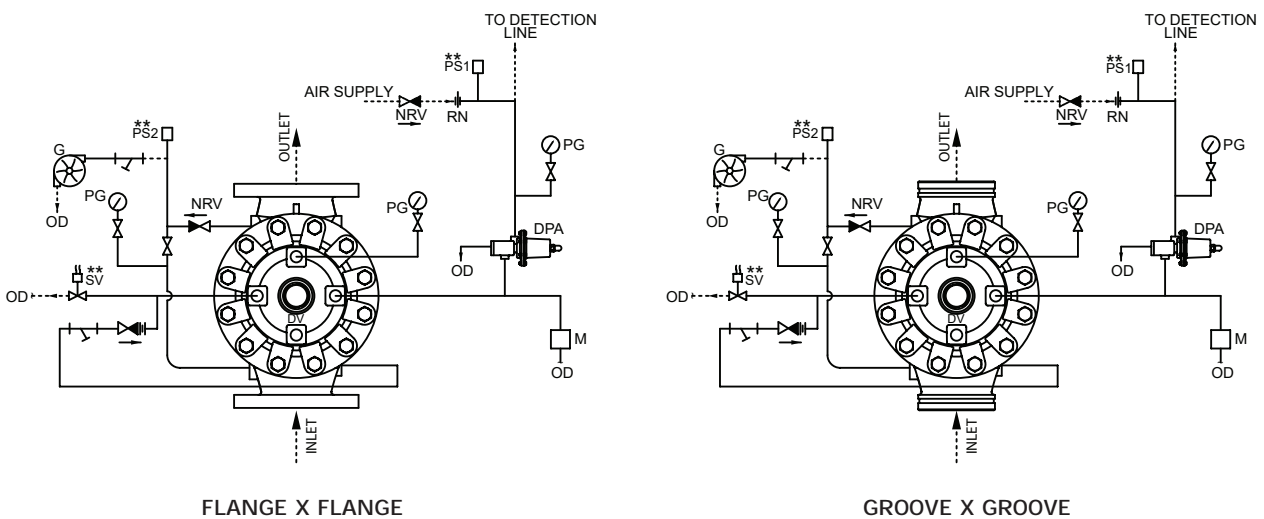

**SCHEMATIC FOR BASIC DRY PILOT TRIM FOR DELUGE VALVE
MODEL - H2 FOR VERTICAL MOUNTING**

ETD-T



SCHEMATIC 4

ABBREVIATION & SYMBOLS

DV	DELUGE VALVE	G	SPRINKLER ALARM (WMG)		NRV WITH RESTRICTION HEX NIPPLE
M	EMERGENCY RELEASE STATION	PG	PRESSURE GAUGE		VALVE
RN	RESTRICTION NOZZLE (AIR LINE)	OD	OPEN DRAIN		STRAINER
SV	SOLENOID VALVE	DPA	DRY PILOT ACTUATOR	---	BY USER
PS1	LOW AIR ALARM PRESSURE SWITCH	NRV	NON RETURN VALVE		
PS2	WATER FLOW PRESSURE ALARM SWITCH	**	OPTIONAL		

**SCHEMATIC FOR BASIC WET PILOT TRIM FOR DELUGE VALVE
MODEL - H2 FOR VERTICAL MOUNTING**

ETW-D

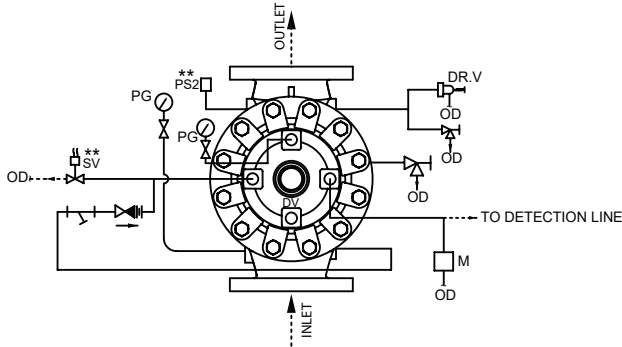

FLANGE X FLANGE

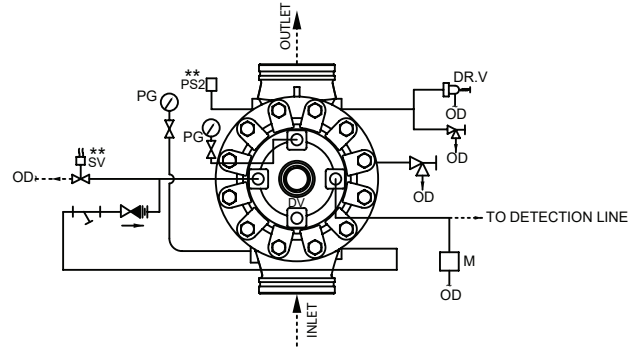

GROOVE X GROOVE

SCHEMATIC 5

**SCHEMATIC FOR BASIC DRY PILOT TRIM FOR DELUGE VALVE
MODEL - H2 FOR VERTICAL MOUNTING**

ETD-D

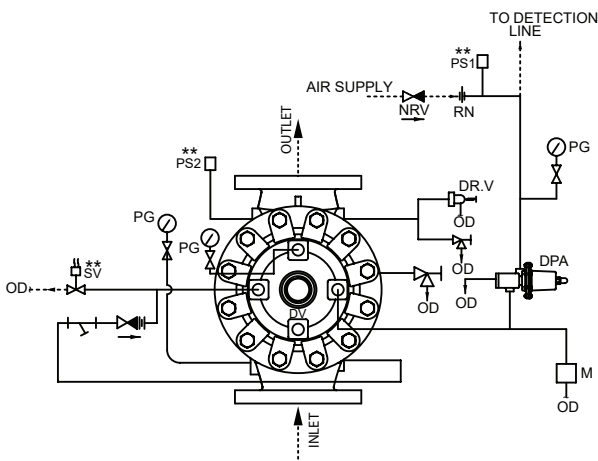



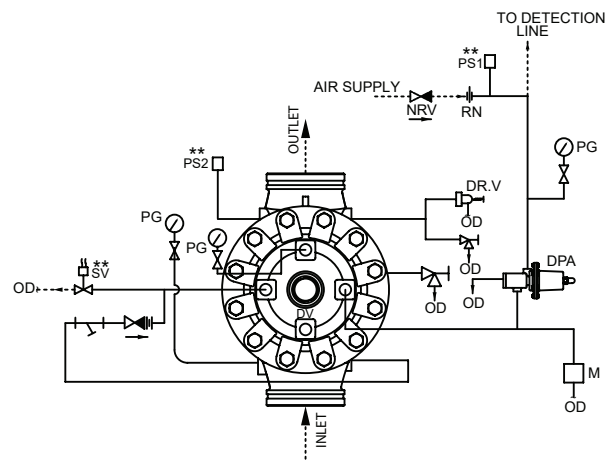

FLANGE X FLANGE



GROOVE X GROOVE

SCHEMATIC 6

ABBREVIATION & SYMBOLS

DV	DELUGE VALVE	G	SPRINKLER ALARM (WMG)		NRV WITH RESTRICTION HEX NIPPLE
M	EMERGENCY RELEASE STATION	PG	PRESSURE GAUGE		VALVE
RN	RESTRICTION NOZZLE (AIR LINE)	OD	OPEN DRAIN		STRAINER
SV	SOLENOID VALVE	DPA	DRY PILOT ACTUATOR		ANGLE VALVE
PS1	LOW AIR ALARM PRESSURE SWITCH	DR.V	DRIP VALVE	---	BY USER
PS2	WATER FLOW PRESSURE ALARM SWITCH	NRV	NON RETURN VALVE	**	OPTIONAL

**SCHEMATIC FOR BASIC WET PILOT TRIM FOR DELUGE VALVE
MODEL - H2 FOR VERTICAL MOUNTING**

NT-W

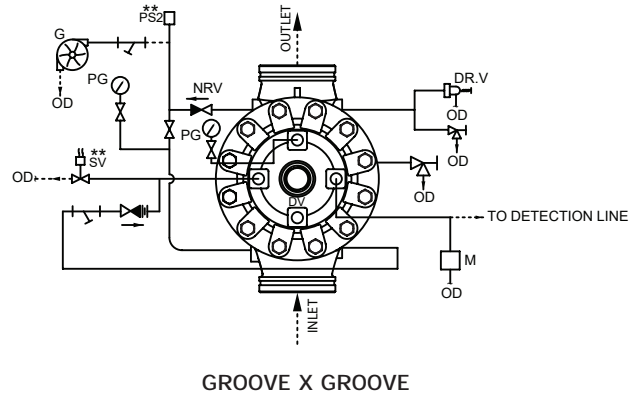
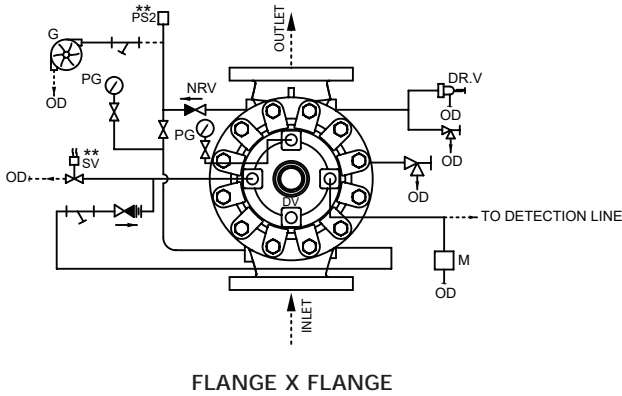

SCHEMATIC 7



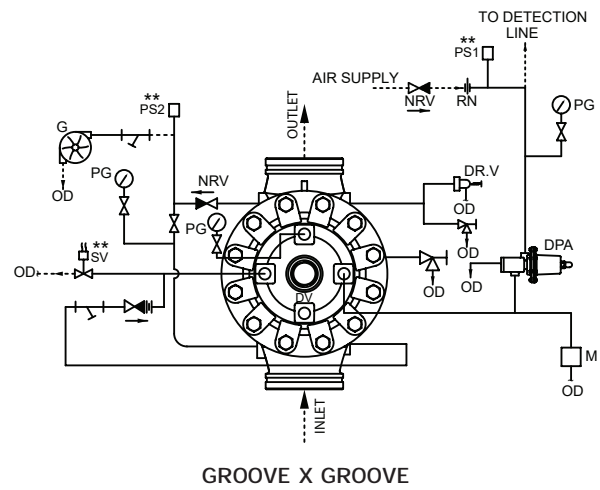
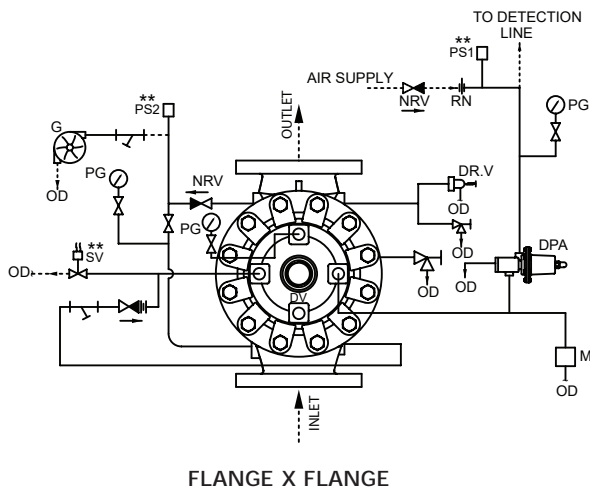

**SCHEMATIC FOR BASIC DRY PILOT TRIM FOR DELUGE VALVE
MODEL - H2 FOR VERTICAL MOUNTING**

NT-D



SCHEMATIC 8

ABBREVIATION & SYMBOLS

DV	DELUGE VALVE	G	SPRINKLER ALARM (WMG)		NRV WITH RESTRICTION HEX NIPPLE
M	EMERGENCY RELEASE STATION	PG	PRESSURE GAUGE		VALVE
RN	RESTRICTION NOZZLE (AIR LINE)	OD	OPEN DRAIN		STRAINER
SV	SOLENOID VALVE	DPA	DRY PILOT ACTUATOR		ANGLE VALVE
PS1	LOW AIR ALARM PRESSURE SWITCH	DR.V	DRIP VALVE	---	BY USER
PS2	WATER FLOW PRESSURE ALARM SWITCH	NRV	NON RETURN VALVE	**	OPTIONAL

**SCHEMATIC FOR BASIC WET PILOT TRIM FOR DELUGE VALVE
MODEL - H2 FOR HORIZONTAL MOUNTING**

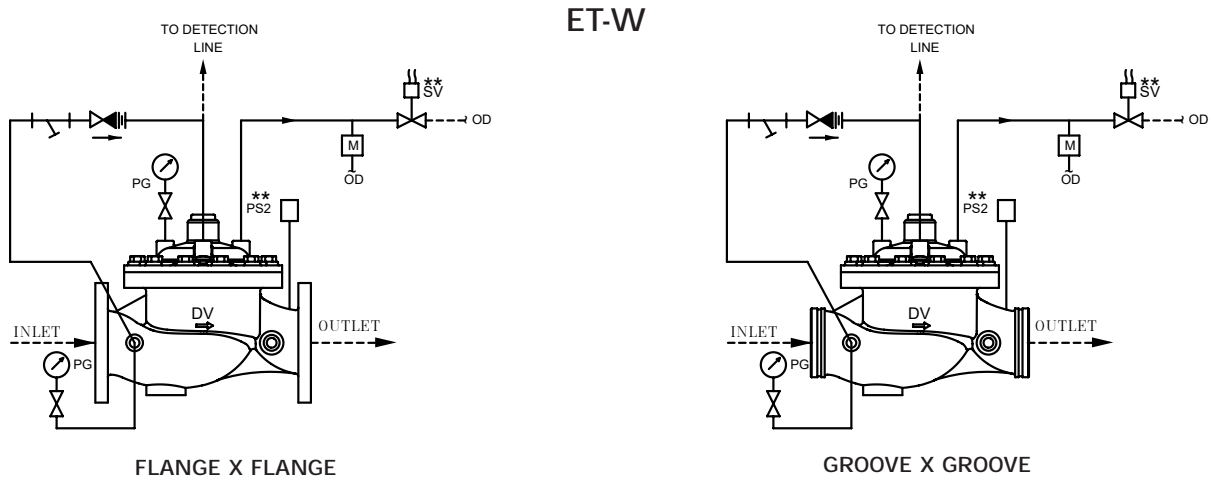

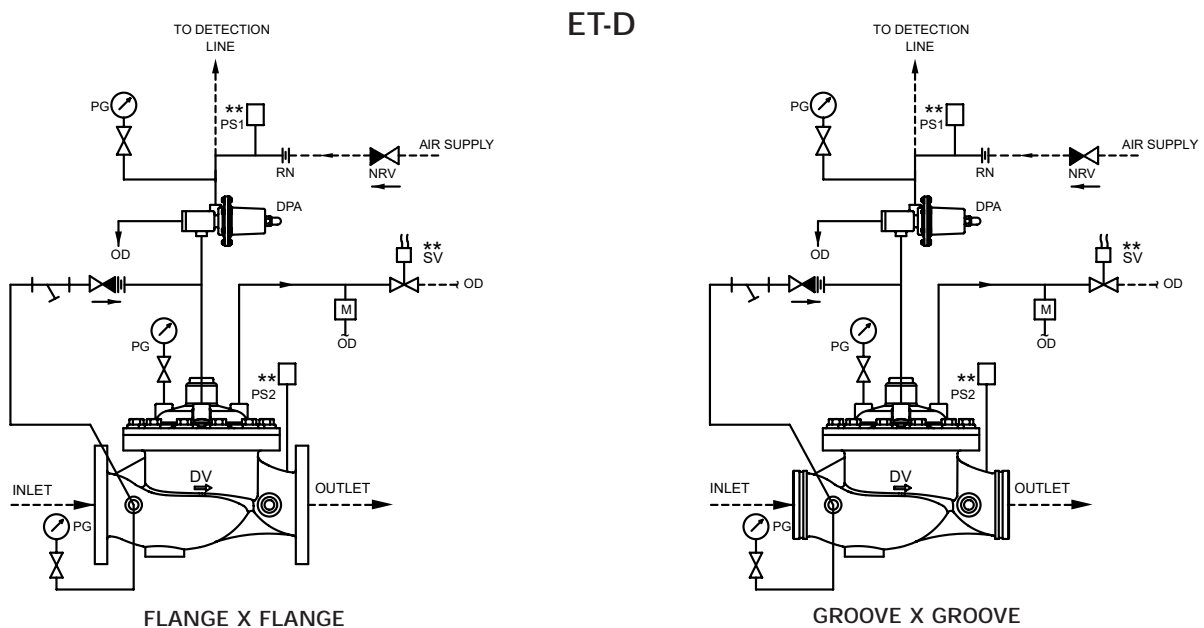

SCHEMATIC 9

**SCHEMATIC FOR BASIC DRY PILOT TRIM FOR DELUGE VALVE
MODEL - H2 FOR HORIZONTAL MOUNTING**



SCHEMATIC 10

ABBREVIATION & SYMBOLS

DV	DELUGE VALVE	G	SPRINKLER ALARM (WMG)		NRV WITH RESTRICTION HEX NIPPLE
M	EMERGENCY RELEASE STATION	PG	PRESSURE GAUGE		VALVE
RN	RESTRICTION NOZZLE (AIR LINE)	OD	OPEN DRAIN		STRAINER
SV	SOLENOID VALVE	DPA	DRY PILOT ACTUATOR	---	BY USER
PS1	LOW AIR ALARM PRESSURE SWITCH	NRV	NON RETURN VALVE		
PS2	WATER FLOW PRESSURE ALARM SWITCH	**	OPTIONAL		

**SCHEMATIC FOR BASIC WET PILOT TRIM FOR DELUGE VALVE
MODEL - H2 FOR HORIZONTAL MOUNTING**

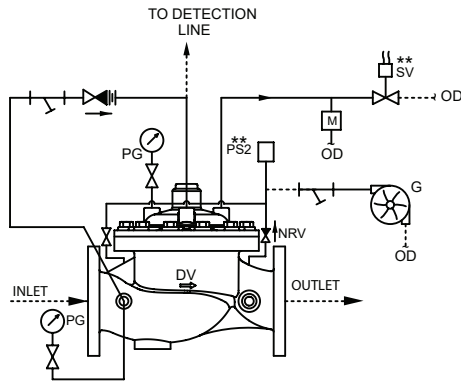

FLANGE X FLANGE

ETW-T

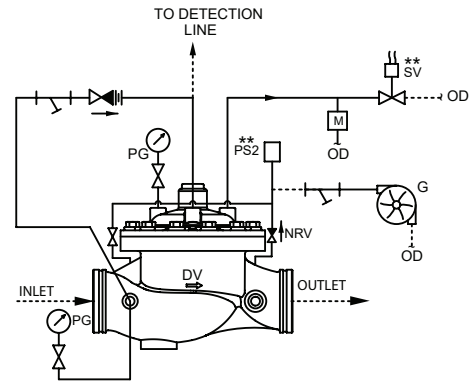

GROOVE X GROOVE

SCHEMATIC 11

**SCHEMATIC FOR BASIC DRY PILOT TRIM FOR DELUGE VALVE
MODEL - H2 FOR HORIZONTAL MOUNTING**

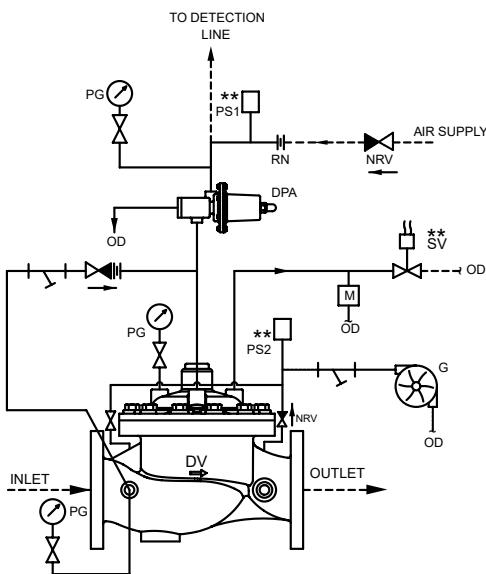

FLANGE X FLANGE

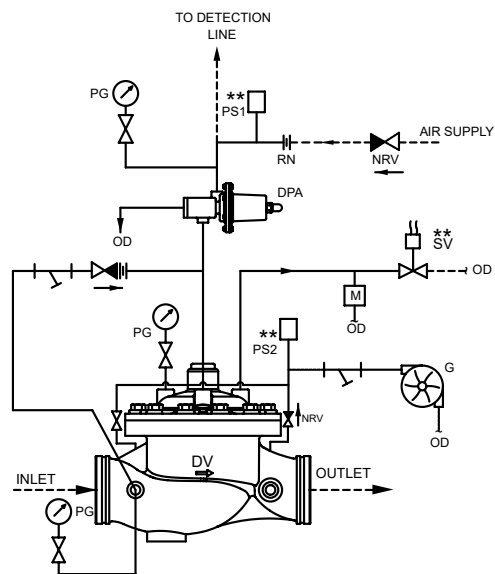

ETD-T



GROOVE X GROOVE

SCHEMATIC 12

ABBREVIATION & SYMBOLS

DV	DELUGE VALVE	G	SPRINKLER ALARM (WMG)		NRV WITH RESTRICTION HEX NIPPLE
M	EMERGENCY RELEASE STATION	PG	PRESSURE GAUGE		VALVE
RN	RESTRICTION NOZZLE (AIR LINE)	OD	OPEN DRAIN		STRAINER
SV	SOLENOID VALVE	DPA	DRY PILOT ACTUATOR	---	BY USER
PS1	LOW AIR ALARM PRESSURE SWITCH	NRV	NON RETURN VALVE		
PS2	WATER FLOW PRESSURE ALARM SWITCH	**	OPTIONAL		

**SCHEMATIC FOR BASIC WET PILOT TRIM FOR DELUGE VALVE
MODEL - H2 FOR HORIZONTAL MOUNTING**

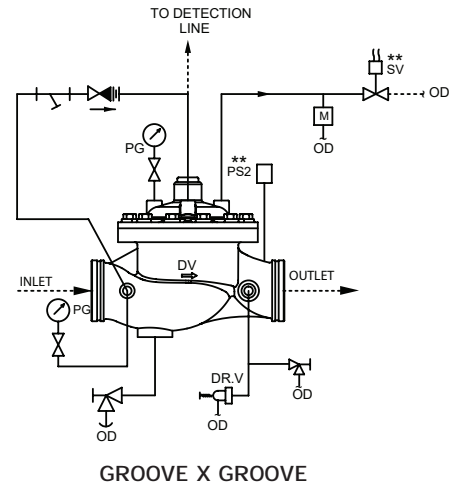
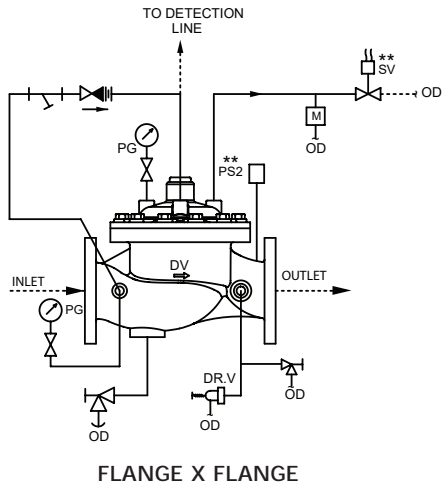

SCHEMATIC 11

**SCHEMATIC FOR BASIC DRY PILOT TRIM FOR DELUGE VALVE
MODEL - H2 FOR HORIZONTAL MOUNTING**

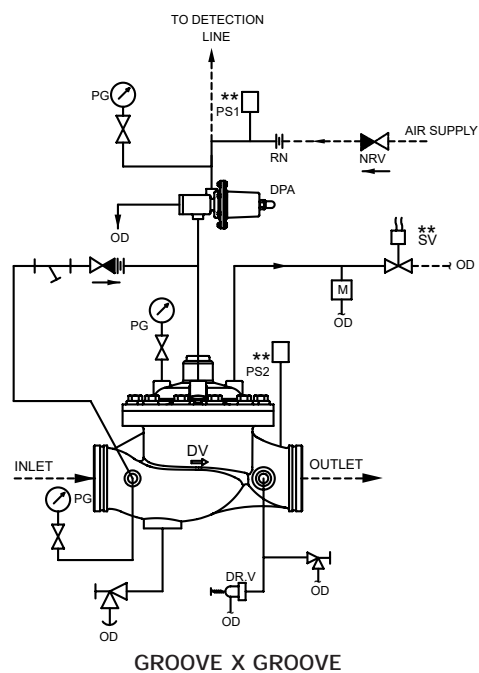
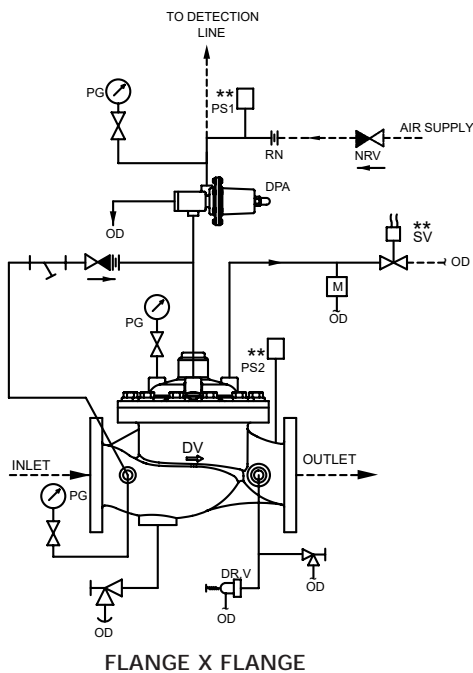

SCHEMATIC 14

ABBREVIATION & SYMBOLS			
DV	DELUGE VALVE	G	SPRINKLER ALARM (WMG)
M	EMERGENCY RELEASE STATION	PG	PRESSURE GAUGE
RN	RESTRICTION NOZZLE (AIR LINE)	OD	OPEN DRAIN
SV	SOLENOID VALVE	DPA	DRY PILOT ACTUATOR
PS1	LOW AIR ALARM PRESSURE SWITCH	DR.V	DRIP VALVE
PS2	WATER FLOW PRESSURE ALARM SWITCH	NRV	NON RETURN VALVE
			NRV WITH RESTRICTION HEX NIPPLE
			VALVE
			STRAINER
			ANGLE VALVE
		---	BY USER
		**	OPTIONAL

**SCHEMATIC FOR BASIC WET PILOT TRIM FOR DELUGE VALVE
MODEL - H2 FOR HORIZONTAL MOUNTING**

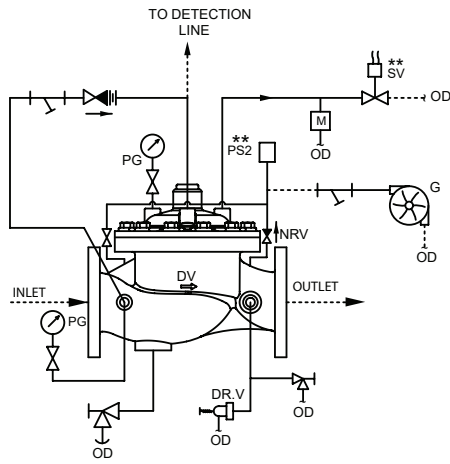

FLANGE X FLANGE

NT-W

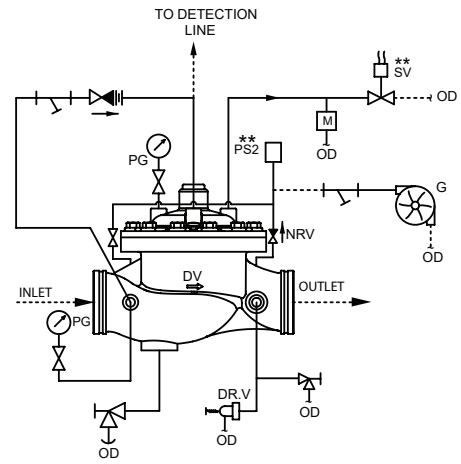

GROOVE X GROOVE

SCHEMATIC 15

**SCHEMATIC FOR BASIC DRY PILOT TRIM FOR DELUGE VALVE
MODEL - H2 FOR HORIZONTAL MOUNTING**

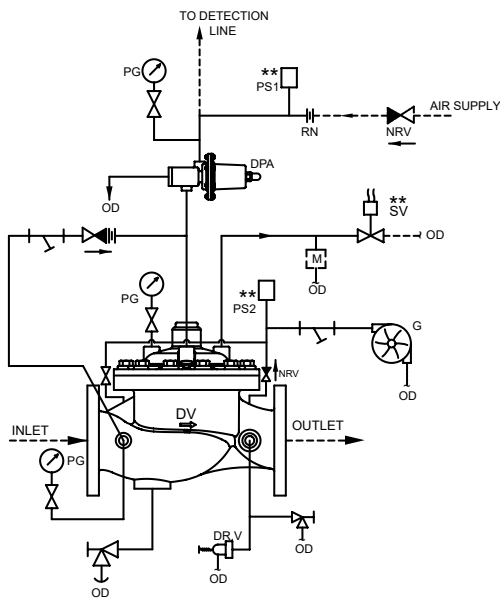

FLANGE X FLANGE



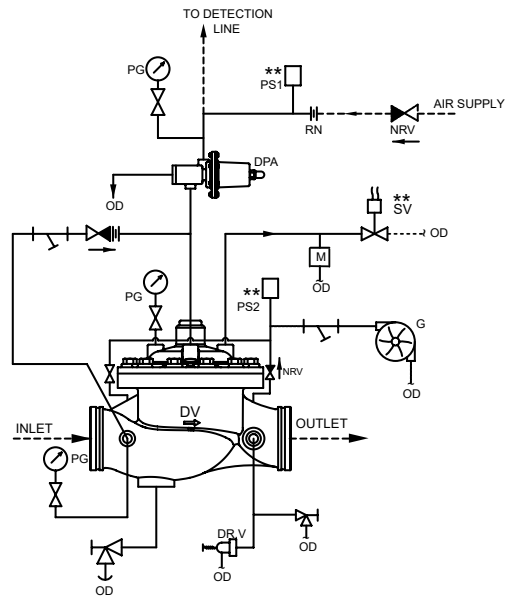

NT-D



GROOVE X GROOVE

SCHEMATIC 16

ABBREVIATION & SYMBOLS

DV	DELUGE VALVE	G	SPRINKLER ALARM (WMG)		NRV WITH RESTRICTION HEX NIPPLE
M	EMERGENCY RELEASE STATION	PG	PRESSURE GAUGE		VALVE
RN	RESTRICTION NOZZLE (AIR LINE)	OD	OPEN DRAIN		STRAINER
SV	SOLENOID VALVE	DPA	DRY PILOT ACTUATOR		ANGLE VALVE
PS1	LOW AIR ALARM PRESSURE SWITCH	DR.V	DRIP VALVE	---	BY USER
PS2	WATER FLOW PRESSURE ALARM SWITCH	NRV	NON RETURN VALVE	**	OPTIONAL

SPRINKLER HEIGHT LIMITATION

DV 200 NB

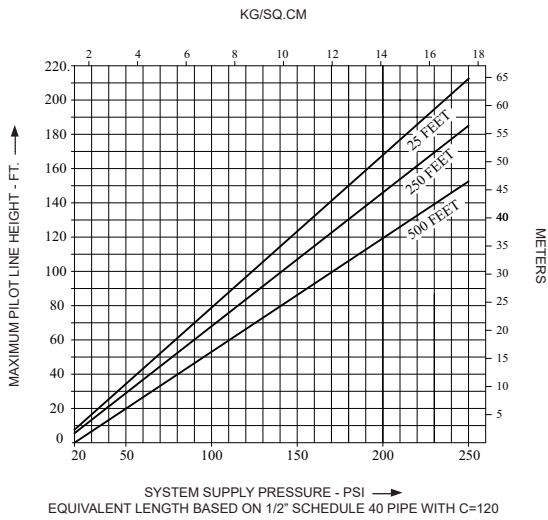

DV 150 NB

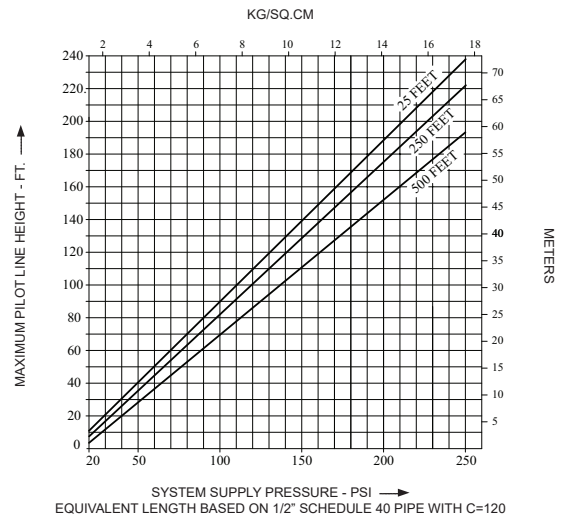

DV 100 NB

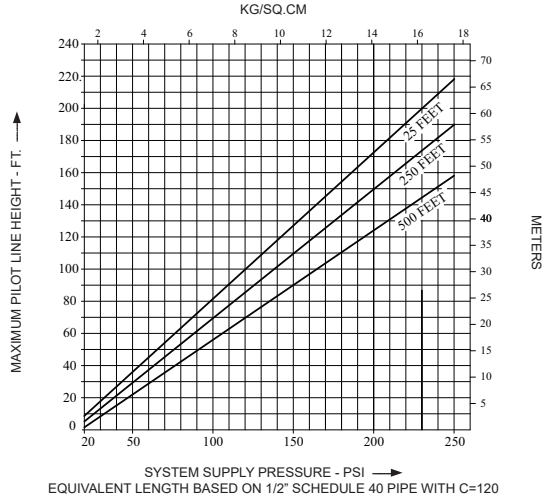

DV 80 NB

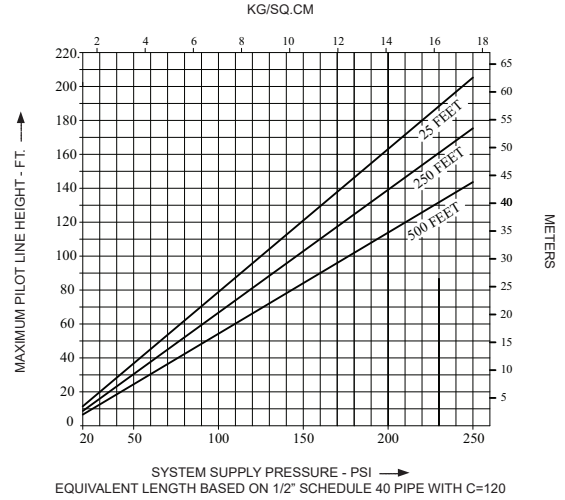

DV - 50 NB

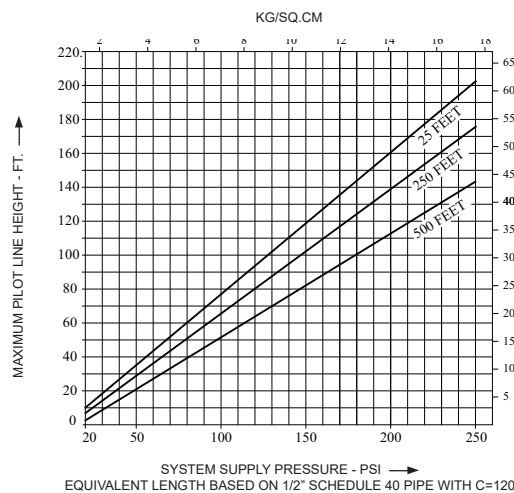

DELUGE VALVE MODEL H2

Nominal Pressure Loss vs Flow

(* Flow at 15 feet per second [4.57 meter per second]) velocity

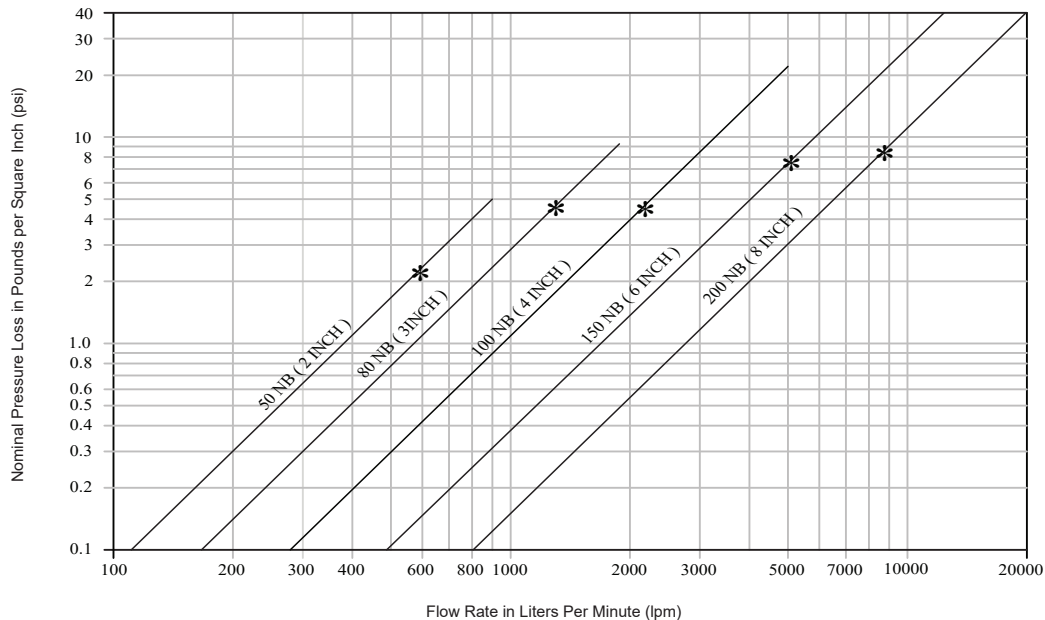

- * 2.3 psi Pressure loss @ 15 feet per second (4.57 m/s) velocity having flow of 594 lpm through 50NB DV
- * 4.7 psi Pressure loss @ 15 feet per second (4.57 m/s) velocity having flow of 1308 lpm through 80NB DV
- * 4.7 psi Pressure loss @ 15 feet per second (4.57 m/s) velocity having flow of 2255 lpm through 100NB DV
- * 7.5 psi Pressure loss @ 15 feet per second (4.57 m/s) velocity having flow of 5117 lpm through 150NB DV
- * 8.4 psi Pressure loss @ 15 feet per second (4.57 m/s) velocity having flow of 8854 lpm through 200NB DV

LIMITED WARRANTY

HD FIRE PROTECT PVT. LTD. hereby referred to as HD FIRE warrants to the original purchaser of the fire protection products manufactured by HD FIRE and to any other person to whom such equipment is transferred, that such products will be free from defect in material and workmanship under normal use and care, for two (2) years from the date of shipment by HD FIRE. Products or Components supplied or used by HD FIRE, but manufactured by others, are warranted only to the extent of the manufacturer's warranty. No warranty is given for product or components which have been subject to misuse, improper installation, corrosion, unauthorized repair, alteration or un-maintained. HD FIRE shall not be responsible for system design errors or improper installation or inaccurate or incomplete information supplied by buyer or buyer's representatives. HD FIRE will repair or replace defective material free of charge, which is returned to our factory, transportation charge prepaid, provided after our inspection the material is found to have been defective at the time of initial shipment from our works. HD FIRE shall not be liable for any incidental or consequential loss, damage or expense arising directly or indirectly from the use of the product including damages for injury to person, damages to property and penalties resulting from any products and components manufactured by HD FIRE. HD FIRE shall not be liable for any damages or labour charges or expense in making repair or adjustment to the product. HD FIRE shall not be liable for any damages or charges sustained in the adaptation or use of its engineering data & services. In no event shall HD Fire's product liability exceed an amount equal to the sale price. The foregoing warranty is exclusive and in lieu of all other warranties and representation whether expressed, implied, oral or written, including but not limited to, any implied warranties or merchantability or fitness for a particular purpose. All such other warranties and representations are hereby cancelled.

NOTICE :

The equipment presented in this bulletin is to be installed in accordance with the latest publication standards of NFPA or other similar organisations and also with the provision of government codes or ordinances wherever applicable.

The information provided by us is to the best of our knowledge and belief, and consist of general guidelines only. Site handling and installation control is not in our scope. Hence we give no guarantee for result and take no liability for damages, loss or penalties whatsoever, resulting from our suggestion, information, recommendation or damages due to our product.

Product development is a continuous programme of HD FIRE PROTECT PVT. LTD. and hence the right to modify any specification without prior notice is reserved with the company.